

# Pediatric Laparoscopy

## Paediatric Laparoscopy



<b>İçindekiler - Laparoskopi</b> Table of contents - Laproscopy	<b>Sayfa</b> Page
<b>Trokar kılıfları, Trokarlar</b> Trocar sleeves, trocars	3
<b>Otoklavlanabilir Laparoskoplar</b> Autoclavable Laparoscopes	4
<b>Fiber ışık kabloları, HF-Bağlantı Kabloları</b> Fibre light cables, HF connection cables	5
<b>Kanca Elektrotlar</b> Hook electrodes	6
<b>Dönebilen ve Sökülebilen Aletler</b> Rotating and detachable Instruments	7 - 10
<b>Aplikatörler ve Düğüm Kılavuz Aletleri</b> Applicators and Knot guide instruments	10
<b>Endo-Kanca Sistem</b> Endo-Hook-System	11
<b>Bakım ve Temizlik</b> Care and Cleaning	<b>bkz: LAP.</b> see LAP

Trokar Kılıfları, Trokarlar  
Trocar sleeves, Trocars



29-00230

Trokar kılıfı Ø 3,0 mm  
Çalışma uzunluğu 40 mm  
Boru ve musluk içinde set:

29-00230

Trocar sleeve Ø 3,0 mm  
working length 40 mm  
with trumpet and stop cock



29-01430

Trokar Ø 3,0 mm,  
Ç.Uzunluğu 82 mm  
Piramit Sivri uç

29-01430

Trocar Ø 3,0 mm  
working length 82 mm  
with pyramidal point



29-02430

Trokar Ø 3,0 mm  
Ç.Uzunluğu 83 mm  
koni uç

29-02430

Trocar Ø 3,0 mm  
working length 83 mm  
conical



29-00733

Otomatik Trokar Kılıfı Ø 3,5 mm  
Ç.Uzunluğu 70 mm  
Musluk ve Manuel Kapı dahil set:

29-00733

Automatic trocar sleeve Ø 3,5 mm  
working length 70 mm  
with stop cock and manual  
Trap Door



29-01431

Trokar Ø 3,5 mm,  
Ç.Uzunluğu 132 mm  
Piramit Sivri uç

29-01431

Trocar Ø 3,5 mm  
working length 132 mm  
with pyramidal point



29-02431

Trokar Ø 3,5 mm  
Ç.Uzunluğu 134 mm  
koni uç

29-02431

Trocar Ø 3,5 mm  
Working length 134 mm  
conical

**Otoklavlanabilir Laparoskop**  
Autoclavable Laparoscopes

Tüm teleskoplar aşağıdaki markalara uyumlu  
3 yönlü konektörlerle donatılmışlardır.

ACM, WOLF, STORZ, OLYMPUS

All telescopes are equipped with a 3-way variable cable  
connector to connect the following systems:

ACM, WOLF, STORZ, OLYMPUS



Tüm laparoskopi optikleri  
2,3 bar (134°C)'de otoklavlanabilir.

19-27000      Ø 2,7 mm, 0° derece  
19-27003      Ø 2,7 mm, 30° derece

Optics for Laparoscopy  
autoclavable at 2,3 bar (134°C)

19-27000      Ø 2,7 mm, view 0°  
19-27003      Ø 2,7 mm, view 30°

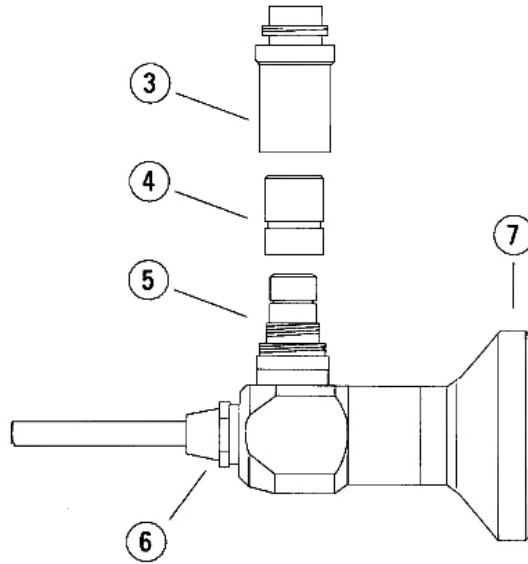

Adapter für Optiken

- ③ Storz®/Olympus® - Adaptör
- ④ Wolf® - Adaptör
- ⑤ ACM® - Konektör
- ⑥ Storz® - Konektör
- ⑦ Mercek

Adapter for optics

- ③ Storz®/Olympus® - adapter
- ④ Wolf® - adapter
- ⑤ ACM® - connector
- ⑥ Storz® - connector
- ⑦ Eyepiece

Fiber Işık kabloları  
Fibre Light cables



FİBER IŞIK KABLOLARI 2,3 bar (134°C)'de otoklavlanabilir

Fibre Light cables, autoclavable at 2,3 bar (134°C)

Cihaz Adaptörü Equipment adapter	Endoskop-Adaptörü Endoscope adapter	Ø [mm]	Uzunluk 1800 mm Length 1800 mm	Uzunluk 2300 mm Length 2300 mm	Uzunluk 3000 mm Length 3000 mm
Endoser / Storz	Endoser / Storz	3,5	31-00150	31-00151	31-00152
Endoser / Storz	Endoser / Storz	4,8	31-00200	31-00201	31-00202
Winter / Ibe	Endoser / Storz	3,5	31-00160	31-00161	31-00162
Winter / Ibe	Endoser / Storz	4,8	31-00210	31-00211	31-00212
Wolf / HSW	Wolf / HSW	3,5	31-00170	31-00171	31-00172
Wolf / HSW	Wolf / HSW	4,8	31-00220	31-00221	31-00222
ACM / British	ACM / British	3,5	31-00180	31-00181	31-00182
ACM / British	ACM / British	4,8	31-00230	31-00231	31-00232

Yüksek Performanslı Işık Kaynakları için,  
Daha güçlü ışık kabloları / Otoklavlanabilir- 2,3bar (134°C)

High Power Light cables for Light Sources with  
high performance,  
autoclavable at 2,3 bar (134°C)

Cihaz Adaptörü Equipment adapter	Endoskop-Adaptörü Endoscope adapter	Ø [mm]	Uzunluk 1800 mm Length 1800 mm	Uzunluk 2300 mm Length 2300 mm	Uzunluk 3000 mm Length 3000 mm
Endoser / Storz	Endoser / Storz	3,5	31-00540	31-00541	31-00542
Endoser / Storz	Endoser / Storz	4,8	31-00500	31-00501	31-00502
Winter / Ibe	Endoser / Storz	3,5	31-00550	31-00551	31-00552
Winter / Ibe	Endoser / Storz	4,8	31-00510	31-00511	31-00512
Wolf / HSW	Wolf / HSW	3,5	31-00560	31-00561	31-00562
Wolf / HSW	Wolf / HSW	4,8	31-00520	31-00521	31-00522
ACM / British	ACM / British	3,5	31-00570	31-00571	31-00572
ACM / British	ACM / British	4,8	31-00530	31-00531	31-00532

HF-Bağlantı Kabloları  
HF connection cable



28-00000

HF-Bağlantı Kabloları,  
Giriş-Çıkış, Uzunluk 3,5 m

28-00000

RF connection cable,  
plug-socket, length 3,5 m

Kanca uęlu Elektrotlar  
Hook-tip electrodes

Kanca uęlu Elektrot,azami ۆlęde izolasyonlu

Hook-tip electrodes insulated on the front, to max. extend



40-27015 Kunt,  
Ø 2,7 mm, Boru uzunluęu 150 mm

40-27015 blunt,  
Ø 2,7 mm, tube length 150 mm

40-27023 Kunt,  
Ø 2,7 mm, Boru uzunluęu 230 mm

40-27023 blunt,  
Ø 2,7 mm, tube length 230 mm



40-27115 Kunt,  
Ø 2,7 mm, Boru uzunluęu 150 mm

40-27115 blunt,  
Ø 2,7 mm, tube length 150 mm

40-27123 Kunt,  
Ø 2,7 mm, Boru uzunluęu 230 mm

40-27123 blunt,  
Ø 2,7 mm, tube length 230 mm



40-27215 Elmas yzey kesitli,  
Ø 2,7 mm, Boru uzunluęu 150 mm

40-27215 diamond shaped cutting surface  
Ø 2,7 mm, tube length 150 mm

40-27223 Elmas yzey kesitli,  
Ø 2,7 mm, Boru uzunluęu 230 mm

40-27223 diamond shaped cutting surface  
Ø 2,7 mm, tube length 230 mm

**Dönebilen ve Sökülebilir Aletler**  
Rotating and Detachable Instruments

Onaylanmış uzun araç tasarımlarımız sayesinde, her bir temel araç parçaları farklı kollar ile uyumlu kombine edilebilir.

Bu sayede, eğer araç uçlarında aşınma meydana gelirse, sadece yeni bir uç alarak tasarruf edersiniz. Eski modellerdeki gibi komple bir araç satın almanıza gerek yoktur.

Endoser ayrılabilir parçalar size en iyi enfeksiyona karşı koruma da sağlar. Bu kullanıcı dostu parçalar kolaylıkla sökülüp takılabilir ve temizlenebilir. Tek tek sipariş edilebilir parçalar sayesinde maliyetinizi açıkça düşürmüş olacaksınız.

Through the principle of the design of these long approved instruments, the basic elements of each instrument can be combined with different handles.

In case of erosion of the instruments insert, it can be replaced by a new one. This leads to a clear lowering of costs, as only the instruments insert has to be exchanged and not the complete instrument.

The detachable ENDOSER instruments offer therefore best possible protection against infection, and they are user-friendly through a easy disassembly and the combination of the instrument inserts with various handles. As the basic elements like handle and instrument insert can be ordered separately they are cost lowering. These instruments offer a clearly improved cost use relation.

MONTE EDİLMİŞ ARAÇ

ASSEMBLED INSTRUMENT















SÖKÜLMÜŞ ARAÇ

DISASSEMBLED INSTRUMENT













Öncüct.Dkqr ukHqtugr ungt.Mcxtc{ ,e,"Hqtugr ungtÖ"4.9o o "  
ekuuqtu.Dkqr ukHqtugr uI tcur lpi "Hqtugr u"Ö"4.9"o o "

	Uzunluk Working length	Kol Handle 28-000-001	Kol Handle 28-000-003	Kol Handle 28-000-005	Kol Handle 28-000-007
	150 mm				
	230 mm				
	330 mm				
	Ürün Nr. Insert no.	Komple Araç 2,7 mm Complete Instrument 2,7 mm			
		Kanca Makas,Düz Hook scissors, straight			
	23-005-100	23-005-101			
	23-006-100	23-006-101			
	24-006-100	24-006-101			
		Mikro-Makas, Düz Micro scissors, straight			
	23-009-300			23-009-305	
	23-010-300			23-010-305	
	24-010-300			24-010-305	
		Mikro-Makas, Sola Kıvrımlı Micro scissors, curved left			
	23-011-300			23-011-305	
	23-012-300			23-012-305	
	24-012-300			24-012-305	
		Biyopsi Forseps Biopsy forceps			
	23-015-300			23-015-305	
	23-016-300			23-016-305	
	24-016-300			24-016-305	
		Biyopsi Forseps Biopsy forceps			
	23-017-100	23-017-101			
	23-018-100	23-018-101			
	24-018-100	24-018-101			
		Biyopsi Forseps Biopsy forceps			
	23-019-300			23-019-305	
	23-020-300			23-020-305	
	24-020-300			24-020-305	
		Kavrayıcı forseps,Mandallı Grasping forceps with ratchet			
	23-021-300				23-021-307
	23-022-300				23-022-307
	24-022-300				24-022-307
		Kavrayıcı forseps,Mandallı Grasping forceps with ratchet			
	23-023-300				23-023-307
	23-024-300				23-024-307
	24-024-300				24-024-307









Kavrayıcı ve Diseksiyon Forsepsler 2,7mm  
Grasping and dissecting forceps . 2,7 mm

	uzunluk Working length	Kol Handle 28-000-001	Kol Handle 28-000-003	Kol Handle 28-000-005	Kol Handle 28-000-007
		150 mm 230 mm 330 mm			
	ürün Nr. Insert no.	Komple Cihaz 2,7 mm Complete Instrument 2,7 mm			
	Kavrayıcı forseps,Mandallı Grasping forceps with ratchet				
	23-025-300				23-025-307
	23-026-300				23-026-307
	24-026-300				24-026-307
	Kavrayıcı forseps,Mandallı Grasping forceps with ratchet				
	23-027-300				23-027-307
	23-028-300				23-028-307
	24-028-300				24-028-307
	Diseksiyon Forseps Dissecting forceps				
	23-029-300			23-029-305	
	23-030-300			23-030-305	
	24-030-300			24-030-305	
	Diseksiyon Forseps Dissecting forceps				
	23-033-300			23-033-305	
	23-034-300			23-034-305	
	24-034-300			24-034-305	
	Diseksiyon Forseps Dissecting forceps				
	23-035-100	23-035-101			
	23-036-100	23-036-101			
	24-036-100	24-036-101			
	Diseksiyon Forseps MARYLAND Dissecting forceps MARYLAND				
	23-037-300			23-037-305	
	23-038-300			23-038-305	
	24-038-300			24-038-305	
	Diseksiyon Forseps MARYLAND Dissecting forceps MARYLAND				
	23-039-100	23-039-101			
	23-040-100	23-040-101			
	24-040-100	24-040-101			
	Kavrayıcı forseps,mandallı, ALLIS Grasping forceps with ratchet ALLIS				
	23-041-300				23-041-307
	23-042-300				23-042-307
	24-042-300				24-042-307

**Kavrayıcı Forseps,İğne Tutucu,Ø 2,7 mm**

Grasping Forceps,Needel holder Ø2,7mm

	Uzunluk Working length	Kol Handle 28-000-001	Kol Handle 28-000-003	Kol Handle 28-000-005	Kol Handle 28-000-007
	150 mm				
	230 mm				
	330 mm				
	Ürün Nr. Insert no.	Komple Cihaz 2,7 mm Complete Instrument 2,7 mm			
		Kavrayıcı Forseps Grasping forceps HI			
	23-045-300				23-045-307
	23-046-300				23-046-307
	24-046-300				24-046-307
		Kavrayıcı Forseps KOCHER De Bakey Grasping forceps KOCHER De Bakey			
	23-049-300				23-049-307
	23-050-300				23-050-307
	24-050-300				24-050-307
		İğne Tutucu Needle holder			
	23-053-300				23-053-307
	23-054-300				23-054-307
	24-054-300				24-054-307

**Applikatörler ve Düğüm Kaydırma Klavuzları Ø 5 mm**  
Applicators and Knot guide instruments Ø 5 mm



25-00510

Applikatör , Endo-Düğüm için  
Uzunluk 60 mm

25-00510

Applicator for Endo-ligature  
length 60 mm



25-00511

Düğüm Kaydırıcı

25-00511

Knot-Sliding instrument



25-00512

Düğüm klavuzu,Ekstrakorporel düğümleme için,  
(Sadece Applikator 25-00510  
için kullanılır)

25-00512

Knot guide for  
extracorporeal knotting  
(only usable with applicator  
25-00510)

Endo-Kanca-Sistemi

Endo Hook System

Monteli Araç

ASSEMBLED INSTRUMENT



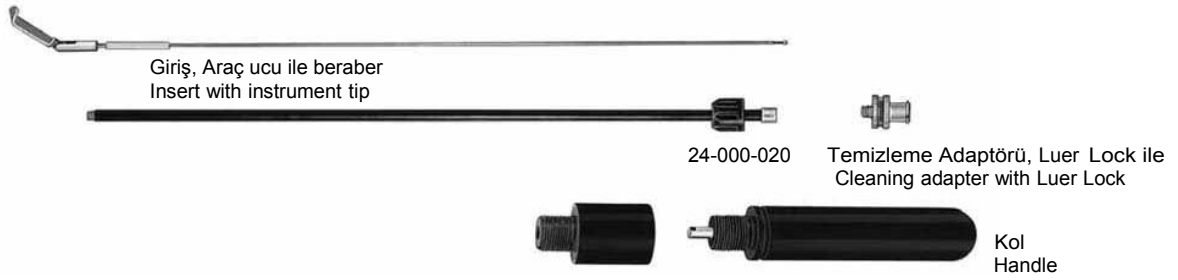

Sökülmüş Araç

DISASSEMBLED INSTRUMENT



Endo-Retraktörler, Ø 2,7 mm  
Endo-Retractors, Ø 2,7 mm

	Çene uzunluğu Jaw lengths	Ø	Çalışma Uzunluğu Working length	Kol Ø 5 mm Handle 28-000-059	
			150 mm 230 mm		
			Einsatz Nr. Ürün no.	Komple Araç Complete Instrument	
				Endo-Retraktör, Kocher-Langenbeck Endo-Retractor Kocher Langenbeck	
	10 mm	2,7 mm	23-101-100	23-101-159	
	10 mm	2,7 mm	23-104-100	23-104-159	
	15 mm	2,7 mm	23-102-100	23-102-159	
	15 mm	2,7 mm	23-105-100	23-105-159	
	20 mm	2,7 mm	23-103-100	23-103-159	
				Endo-Retraktör, Fan Şeklinde Endo-Retractor fan-shaped	
	10 mm	2,7 mm	23-010-100	23-010-159	
	10 mm	2,7 mm	23-011-100	23-011-159	